

# Power

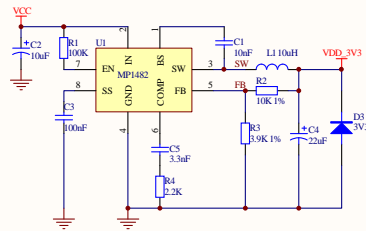

# RS232

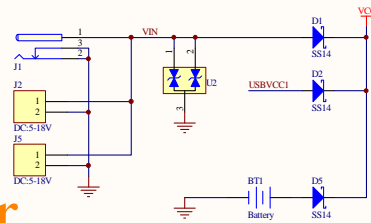
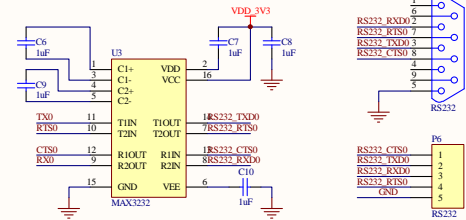

# USB

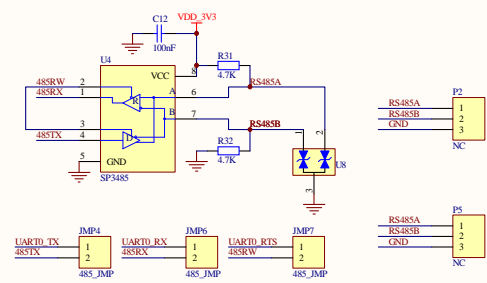
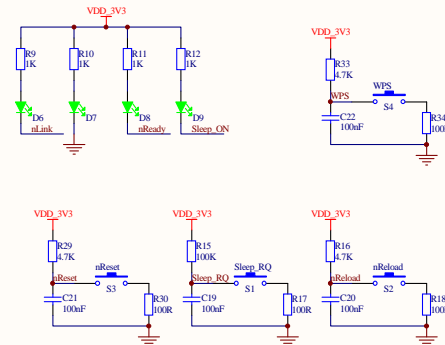
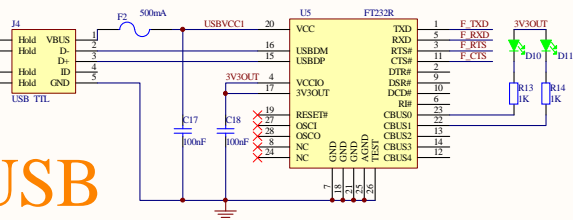

# WIFI

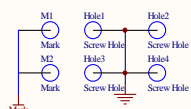
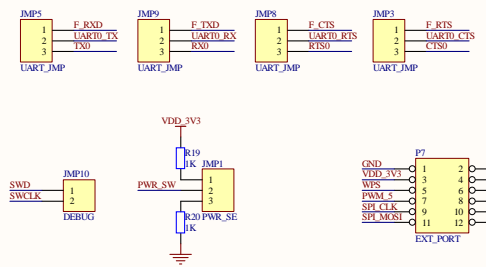
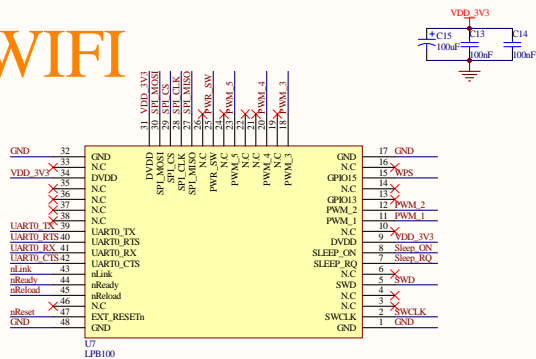

|       |  |          |
|-------|--|----------|
| Title |  |          |
| Size  | Number   | Revision |
| A3    |  |          |
| Date  | 19-Aug-2013  | Sheet of |
| File  | G:\USR-WIFI-LOWPOWER\LPB-100\F1P-B100\F1P-V1.0\F1P-B100-V1.0.DDB |          |